



Grayhill, Inc.

62S11-N4-120S

Gawo la Nambala:

Wopanga / Chinthu:

Mafotokozedwe Akatundu

Datasheets:

Mkhalidwe wa RoHS

Zolembe

Chombo Chochochera

Njira Yopereker

62S11-N4-120S

Grayhill, Inc.

ROTARY ENCODER OPTICAL 32PPR

 62S11-N4-120S.pdf

 Kutsogolera / RoHS Kumvera

2038 pcs stock

Hong Kong

DHL/Fedex/TNT/UPS/EMS

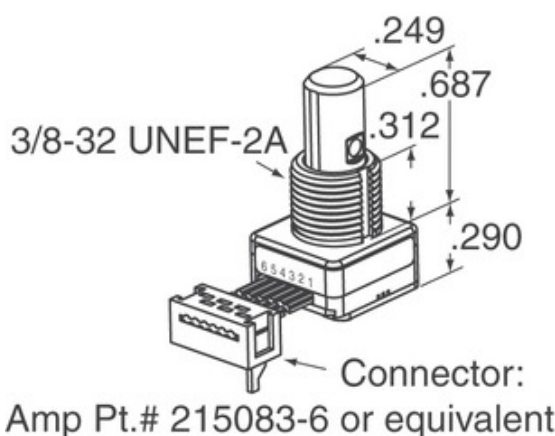

Chithunzi chingakhale choyimira. Onani ndondomeko zogwiritsira ntchito mankhwala.







Mafotokozedwe a 62S11-N4-120S

| | |
|---|---|
| GAWO LA NAMBALA | 62S11-N4-120S |
| WOPANGA | Grayhill, Inc. |
| KUFOTOKOZERA | ROTARY ENCODER OPTICAL 32PPR |
| MKHALIDWE WOPANDA UFULU / MKHALIDWE WA ROHS | Kutsogolera / RoHS Kumvera |
| CHIWERENGERO CHIPEZEKA | 2038 pcs |
| TSAMBA LAZAMBIRI |  62S11-N4-120S.pdf |
| MPHAMVU - ZOPEREKA | 5V |
| NJIRA YOTHETSER | Cable Leads |
| MNDANDANDA | 62S |
| MOYO WOSINTHASINTHA (ZAMBIRI ZAMAKONO) | 1M |
| PULSES PA REVOLUTION | 32 |
| MTUNDU WOTSATSA | Quadrature (Incremental) |
| MAINA ENA | 62S11N4120S |
| MAFOTOKOZEDWE | Vertical |
| MTUNDU WOKWERA | Panel Mount |
| MPHUNO YOPANDA CHISOKONEZO (MSL) | 1 (Unlimited) |
| MKHALIDWE WOPANDA UFULU / MKHALIDWE WA ROHS | Lead free / RoHS Compliant |
| MTUNDU WA MAKINA | Optical |
| CHIDZIWITSO | No |
| YOMANGIDWA MU KUSINTHA | Yes |
| MTUNDU WOTSATSA | 1/4" Dia Flatted End |

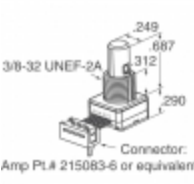
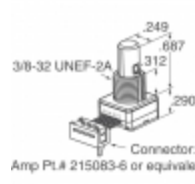
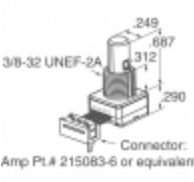
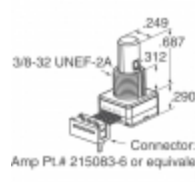
Matanthauzo okhudzana

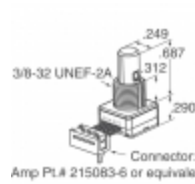
| | | |
|------------------------------|--------------------------------|-------------------------------------|
| Grayhill, Inc. 62S11-N4-120S | AAAA Distributor | 62S11-N4-120S Wopereka |
| 62S11-N4-120S Mtengo | 62S11-N4-120S Zithunzi | 62S11-N4-120S Image |
| 62S11-N4-120S PDF Datasheet | 62S11-N4-120S Dinani Datasheet | 62S11-N4-120S Datasheet |
| 62S11-N4-120S Stock | Gulani 62S11-N4-120S | Gulani Grayhill, Inc. 62S11-N4-120S |
| Grayhill, Inc. 62S11-N4-120S | Grayhill, Inc. Wogulitsa | Grayhill, Inc. Distributor |
| Grayhill, Inc. 62S11-N4-120S | Grayhill Inc. 62S11-N4-120S | |

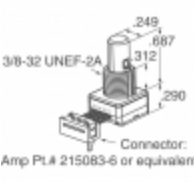
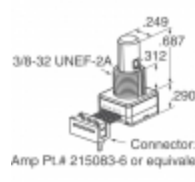
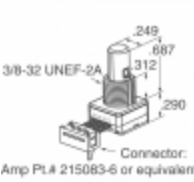
Zogwirizana

| | |
|--|--|
|  <p>62S11-N3-PH Opanga: Grayhill, Inc. Kufotokozera: ROTARY ENCODER OPTICAL 32PPR Zilipo: 1856 pcs</p> <p>RFQ</p> |  <p>62S11-N5-050C Opanga: Grayhill, Inc. Kufotokozera: ROTARY ENCODER OPTICAL 32PPR Zilipo: 1936 pcs</p> <p>RFQ</p> |
|  <p>62S11-N4-PH Opanga: Grayhill, Inc. Kufotokozera: ROTARY ENCODER OPTICAL 32PPR Zilipo: 1970 pcs</p> <p>RFQ</p> |  <p>62S11-N4-P Opanga: Grayhill, Inc. Kufotokozera: ROTARY ENCODER OPTICAL 32PPR Zilipo: 1912 pcs</p> <p>RFQ</p> |
|  <p>62S11-N5-025C Opanga: Grayhill, Inc. Kufotokozera: ROTARY ENCODER OPTICAL 32PPR Zilipo: 2408 pcs</p> <p>RFQ</p> |  <p>62S11-N5-040C Opanga: Grayhill, Inc. Kufotokozera: ROTARY ENCODER OPTICAL 32PPR Zilipo: 2106 pcs</p> <p>RFQ</p> |
|  <p>62S11-N5-025CH Opanga: Grayhill, Inc. Kufotokozera: ROTARY ENCODER OPTICAL 32PPR Zilipo: 2083 pcs</p> <p>RFQ</p> |  <p>62S11-N4-020C Opanga: Grayhill, Inc. Kufotokozera: ROTARY ENCODER OPTICAL 32PPR Zilipo: 2083 pcs</p> <p>RFQ</p> |
|  <p>62S11-N4-060SH Opanga: Grayhill, Inc. Kufotokozera: ROTARY ENCODER OPTICAL 32PPR Zilipo: 2262 pcs</p> <p>RFQ</p> |  <p>62S11-N2-PH Opanga: Grayhill, Inc. Kufotokozera: ROTARY ENCODER OPTICAL 32PPR Zilipo: 1760 pcs</p> <p>RFQ</p> |
|  <p>62S11-N4-025CH Opanga: Grayhill, Inc. Kufotokozera: ROTARY ENCODER OPTICAL 32PPR Zilipo: 1946 pcs</p> <p>RFQ</p> |  <p>62S11-N4-025C Opanga: Grayhill, Inc. Kufotokozera: ROTARY ENCODER OPTICAL 32PPR Zilipo: 1970 pcs</p> <p>RFQ</p> |

Copyright © 2020 wogawana wodalirika wa zamagetsi

Imelo: Info@infinity-electronic.com

Adilesi: 17F, Gaylord Commercial Building, 114-118 Lockhart Road, Wan Chai, Hong Kong

