

Compact Non-contact Door Switch

D40Z/G9SX-NS/G9SP

Wide range of applications
at the highest safety level



» Visible safety

» Ultimate safety level

» Versatile applications

Compliant with Safety PLe/Category 4 (ISO 13849-1)

The compact non-contact feature allows easier installation for a wide range of environments.

The D40Z can be used in work environments under any risk level.
Its combination with safety controllers allows for a wide range of applications.

Electromagnetic Induction Method



Actual Size

〈D40Z〉

Mounts on Either Side

Safety Categories

Different types of machines will have different levels of associated risk. As an index for determining the function to secure safety (safety function) based on the risk evaluation, the ISO 13849-1 which stipulates safety-related parts of control systems, categorizes the capability to maintain safety functions in the event of control system failures as category B to 4.

Performance Level (PL)

An index of the safety control system performance level shared by a person who implements risk assessment and a person who designs a machine is called Performance Level (hereinafter abbreviated as "PL") and has 5 levels of evaluation from "a" to "e".

For details on safety category and PL, refer to page 5.

High level of safety for a wide range of applications

ISO 13849-1 (PLe/Safety Category 4) achieved with Non-contact Door Switches

• Self-diagnostic Function

OMRON's unique electromagnetic induction system for safety was achieved by implementing a detection function for external wiring errors in the Switch.

• Redundant internal circuits

The thorough pursuit of safety is evident in mutual checking by double CPUs.

Series connections

• Up to 30 Switches can be connected to one Controller while maintaining PLe/safety category 4.

The D40Z can be connected to G9SP or G9SX-NS Safety Controllers. Select the best model for your application.

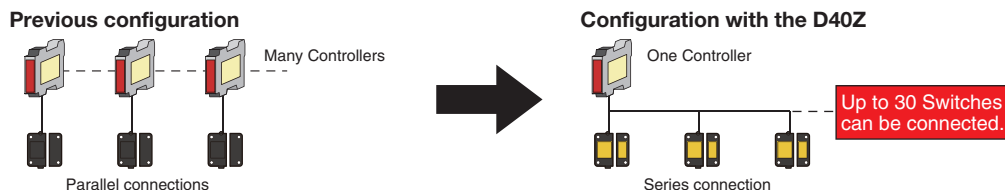

Note 1 : The G9SP supports 2 channels of 15 units each. For more information, refer to *Applicable level and the number of connections according to controller combination* on page 5.

Note 2 : Refer to page 16 for details on safety categories (ISO 13849-1).

How PLe/safety category 4 was achieved with series connections

• Safety software monitoring and diagnosis to detect failures (not possible with series connections of mechanical switches)

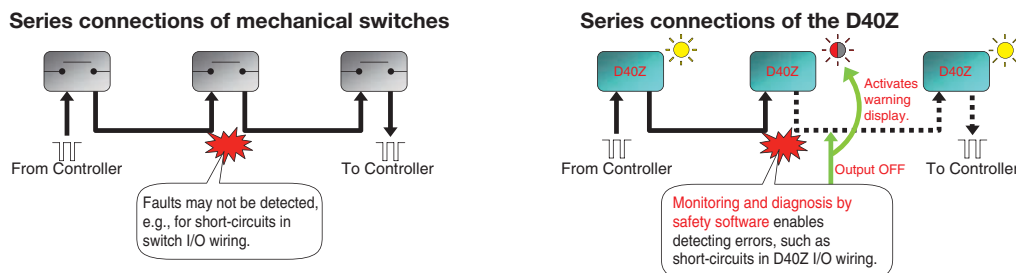

Electromagnetic induction method

• Enables stable detection

With these electronic switches, stable detection is possible even when the door closes slowly.

• No adhesion of iron particles

Permanent magnets are not used, so iron is not attracted, making maintenance easier.

Visible safety

Checking at the production site

The switch's LED indication patterns make identification of abnormal condition possible at the production sites.

Note: For more information, refer to page 10.



- Yellow LED ON : Door closed (normal)
- Yellow LED Blinking : When connected in series; Other D40Zs are turned OFF etc.
- Red LED ON : Door Open
- Red LED Blinking: Error occurred

Centralized monitoring

Bipolar NPN/PNP allows for easy connection with any PLC. The error location can be easily identified. Using a branch relay for a different pole is not required.

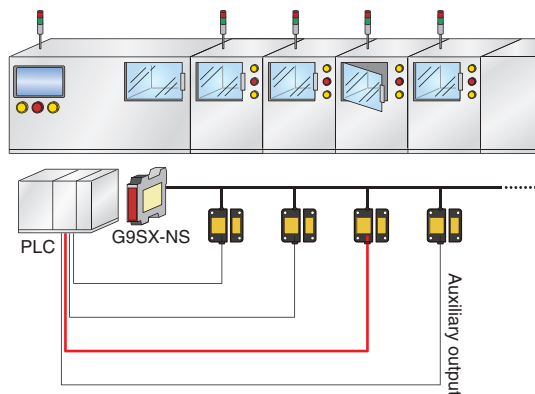

For an easier and safer work environment in all industries. The application of the D40Z will continue to increase in all environments.



Automotive manufacturing (multi-axis robot)

Position detection of a robot (hazard)

Problem

Detecting the position of a multi-axis robot is difficult using a limit switch. Additionally, it is easy to disable the function.

Solution

The non-contact door switch enables ease in detecting the robot position which prevents the operator from easily disabling the function. The maintenance work is safer than ever as the switch conforms to ISO 13849-1 (PLe/safety category 4).

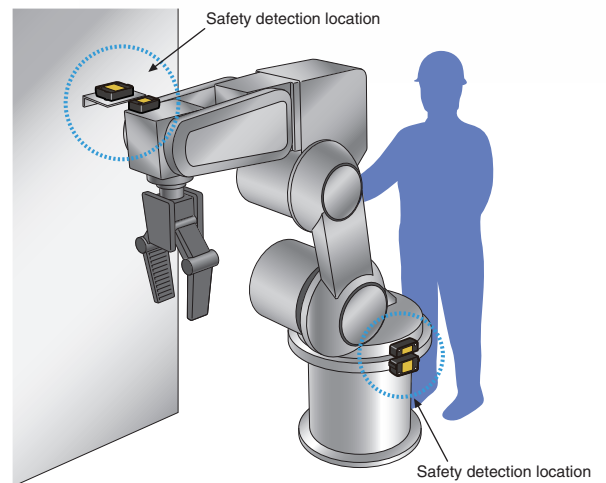

Key factor

Wide detection area
ISO 13849-1 (PLe/Safety Category 4)

D40Z



FPD

Manufacturing process

Problem

There are too many doors, and it takes too long to identify the location of a failure when it occurs.

Solution

Auxiliary output is provided for each switch. As each switch can be monitored, it is possible to pinpoint the location of the failure.

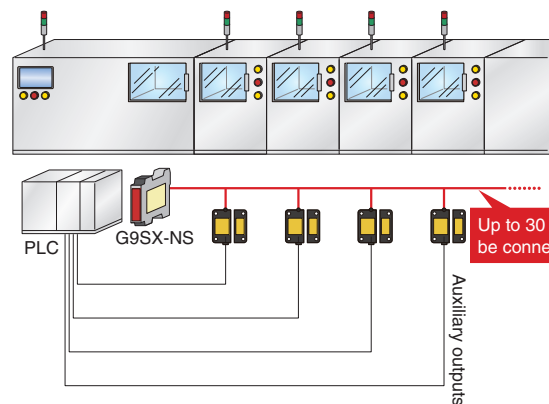

Key factor

PNP/NPN
Up to 30 units connectable

Other Application Examples
Equipment for long production lines

D40Z

The D40Z solves problems at the production sites of various industries that require safety (FPD, automotive parts, food, packaging, multi-axis robot, etc).

The D40Z supports a wide range of risk levels, contributing to a safer environment at production sites for various industries' applications.

	<h3>Food</h3>	<h3>Material processing</h3>
	<h4>Problem</h4>	<p>The machine's small size limits the space available to install a switch.</p>
<h4>Solution</h4>	<p>The D40Z's compact size fits into a narrow space (Switch: 48x48x25 mm, Actuator: 48x48x17 mm). The D40Z can be used at an ambient operating temperature of up to 65°C.</p>	
<h4>Key factor</h4>	<p>Compact size Improvement on ambient operating temperature</p>	

 D40Z

	<h3>Automotive parts</h3>	<h3>Manufacturing process for secondary batteries</h3>
	<h4>Problem</h4>	<p>Although safety is ensured with a contact door switch, particles are generated which affect product quality.</p>
<h4>Solution</h4>	<p>With the non-contact door switch D40Z, no particles will be generated through friction.</p>	
<h4>Key factor</h4>	<p>No particles generation</p>	

Other Application Examples
Cleanrooms

 D40Z

A wide range of choices for the versatile applications

A combination of non-contact door switches and safety controllers can be selected according to the application or the required risk level.

Mounting compatibility with the D40A allows for standardization of machine design.

Non-contact Door Switch ■ **Applicable level and the number of connections according to controller combination**

PL/
Safety
Category

PLe/4



Combination	Safety Category	PL (maximum value)	Number of connectable D40Z Series
G9SP + D40Z	4	PLe	15 x 2 channels*
G9SX-NS + D40Z	4	PLe	30
G9SX-NSA + D40Z	4	PLe	30

PLd/3



Combination	Safety Category	PL (maximum value)	Number of connectable D40A Series
G9SP + D40A	3	PLd	15 x 2 channels*
G9SX-NS + D40A	3	PLd	30
G9SX-NSA + D40A	3	PLd	30

* G9SP-N10S supports 15 x 1 channel.

Safety Controller G9SP

- Combine function blocks for flexible programming
- Extensive system configurations
- Decreased work hours by convenient configurator

Function blocks



G9SP Series Catalog
Catalog No.: J181

Non-contact Door Switch Controller G9SX-NS

- Easy expansion of output points with an expansion unit
- Improved maintainability with LED display
- No special programming required



D40A/G9SX-NS Catalog
Catalog No.: C140

Compact non-contact Door Switch and Safety Controllers

D40Z/G9SX-NS/G9SP

**Supports ISO 13849-1 (PLe/Safety Category 4).
Can be used on higher risk level applications
by connecting to Safety Controllers.**

- Supports a wide range of applications in combination with Safety Controller G9SP or Non-contact Door Switch Controller G9SX-NS□.
- Up to 30 units can be connected.
Ideal for middle to large scale device applications.
- Contributes to shortening the time it takes to find the cause of failure by the switch's LED display patterns.
- Photocoupler monitor output allows connection to a general-purpose PLC (NPN type).
- Compatibility with the D40A allows standardization of machine design.
- Compact Non-contact Door Switch can be mounted from both sides.

 Non-contact Door Switch
 D40Z



Non-contact Door Switch
Controller G9SX-NS□

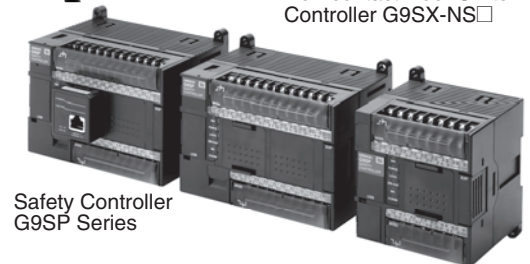

Safety Controller
G9SP Series

For the most recent information on models that have been certified for safety standards, refer to your OMRON website.



Refer to "Safety Precautions" on page 14

Model Number Structure

Model Number Legend

Non-contact Door Switch (Switch/Actuator)

D40Z-□□□
1 2 3

1 Type

1: Standard model (Switch/Actuator)

2 Auxiliary Output

C: 1 NO (Photocoupler Output)

3 Cable length

2: 2 m

5: 5 m

Note: Must be used in combination with a G9SP Safety Controller or G9SX-NS□ Non-contact Door Switch Controller.
For details, refer to G9SP Series Catalog (Cat.No.J181) or D40A/G9SX-NS Catalog (Cat.No.C140).

D40Z/G9SX-NS/G9SP

Ordering Information

Non-contact Door Switch

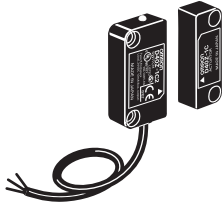
Classification	Appearance	Auxiliary monitoring output	Cable length	Model
Standard models		Photocoupler outputs *1	2 m	D40Z-1C2
			5 m	D40Z-1C5

Note: Must be used in combination with a G9SP Safety Controller or a G9SX-NS□ Non-contact Door Switch Controller.

*1. Photocoupler output. Load current: 10 mA

Non-contact Door Switch Controller G9SX-NS□

Safety outputs *1		Auxiliary monitoring output *3	Logical AND connection input	Logical AND connection output	OFF-delayed Max. OFF-delay time *4	Rated voltage	Terminal block type	Model
Instantaneous	OFF-delayed *2							
2 (Semiconductors)	0	2 (Semiconductors)	1	1	--	24 VDC	Screw terminals	G9SX-NS202-RT
	2 (Semiconductors)						Spring-cage terminals	G9SX-NS202-RC
2 (Semiconductors)		2 (Semiconductors)	1	1	3.0 s	24 VDC	Screw terminals	G9SX-NSA222-T03-RT
	Spring-cage terminals						G9SX-NSA222-T03-RC	

Note: For details, refer to the D40A/G9SX-NS Catalog (C140).

*1. P channel MOS FET transistor output

*2. The OFF-delayed output becomes an instantaneous output by setting the OFF-delay time to 0 s.

*3. PNP transistor output

*4. The OFF-delay time can be set in 16 steps as follows:

0/0.2/0.3/0.4/0.5/0.6/0.7/0.8/0.9/1.0/1.2/1.4/1.8/2.0/2.5/3.0 s

Safety Controller G9SP Series

Name	No. of I/O points				Unit version	Model
	Safety inputs	Test outputs	Safety outputs	Standard outputs		
Safety Controller	10	4	Semiconductor outputs: 4	4	Ver.2.0	G9SP-N10S
	10	6	Semiconductor outputs: 16	--		G9SP-N10D
	20	6	Semiconductor outputs: 8	--		G9SP-N20S

Note: For details, refer to the G9SP Catalog (F090).

Specifications

Ratings and Characteristics (Non-contact Door Switch)

Item	Model	D40Z-1C□
Operating characteristics	Operating distance (OFF → ON)	5 mm min. *1
	Operating distance (ON → OFF)	15 mm max. *1
	Differential travel	20% or less of operating distance at 23 °C (maximum 2.5mm)
	Influence of temperature	20% or less of operating distance at 23 °C within temperature range of -10 to 65 °C
	Repeat accuracy	±10% of operating distance at 23 °C
	Response time (ON → OFF) *2	25 ms max.
	Operating time (OFF → ON) *2	100 ms max. (Distance between the switch and actuator is 5 mm)
Ambient operating temperature		-10 to 65 °C (with no icing or condensation)
Ambient operating humidity		25% to 85%
Insulation resistance (between charged parts and case)		50 MΩ max. (at 500 VDC)
Dielectric strength (between charged parts and case)		1,000 VAC for 1 min
Degree of contamination		3
Electromagnetic compatibility		IEC/EN 60497-5-3 compliant
Vibration resistance		10 to 55 to 10 Hz (single amplitude: 0.75 mm, double amplitude: 1.5 mm)
Shock resistance		300 m/s ² min.
Degree of protection		IP67
Material		PBT resin
Mounting method		M4 screws
Terminal screw tightening torque		1 N·m
Power supply voltage		24 V DC +10%/-15%
Power consumption *3		0.5 W max.
Auxiliary monitoring output		Photocoupler output: 24 V DC, load current: 10 mA
LED indicators		Actuator not detected (lights in red); error occurred (blinks in red), actuator detected (lights in yellow), actuator detected and Non-contact Door Switch input OFF (blinks in yellow)
Connecting cables		2 m, 5 m
Number of connectable switches *4		30 max. (wiring length: 100 m max.)
Weight		Switch: approx. 175 g, actuator: approx. 20 g (D40Z-1C5)

*1. This is the distance where the switch operates from OFF to ON when approaching and the distance where the switch operates from ON to OFF when separating when the switch and actuator target marks are on the same axis, and the sensing surface coincide. For details, refer to "Engineering Data" on page 9.

*2. Indicates the value of the non-contact door switch output.

*3. Power to be provided to the load is not included.

*4. For details, refer to item "Precautions for Correct Use".

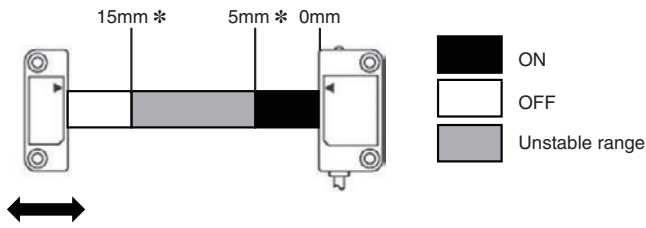

* When the switch and actuator target marks are on the same axis, and the sensing surfaces coincide.

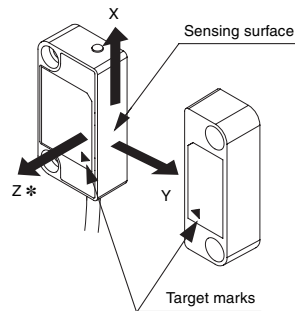
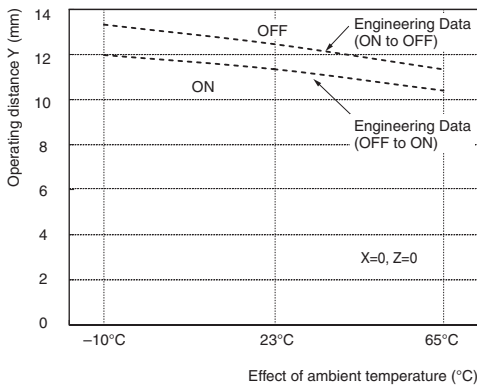
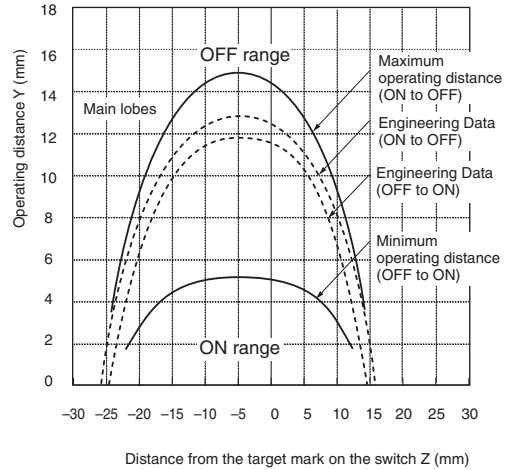
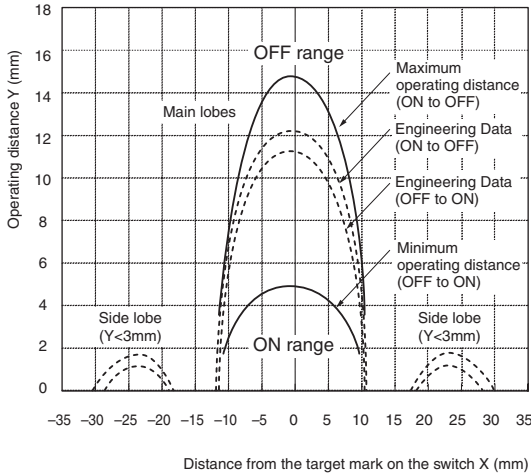

* The movement of the arrow direction indicates the positive direction on the graph.

- Note:**
1. The operating distance is the distance between the switch and actuator sensing surfaces.
 2. Data in the diagram is typical data at an ambient temperature of 23. Actual operating values may vary. The operating distance may be affected by ambient metal, magnet catches, and temperature.
 3. Detection may occur other than on the detection surfaces of the switch and actuator. Before you use the switch and actuator, refer to "Switch and Actuator Operation" on page 17 to set the detection surfaces of the switch and actuator face to face.

Connections

Internal Connection

D40Z-1C□

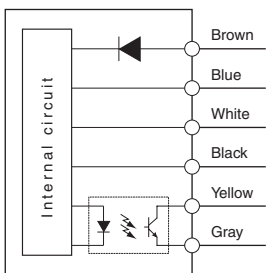

Troubleshooting

LED indicator	Causes and corrective actions *1	
● OFF	Fault in power supply input (brown/blue)	Power supply input may be improperly wired. Check and correct wiring of brown and blue lines. Refer to "Wiring of Inputs and Outputs" on page 11.
		Power supply voltage to D40Z may be insufficient. Check the power supply voltage (between brown and blue lines) of D40Z fills ratings. Refer to "Specifications" on page 8.
		The wiring length or size of the wire may not be to the specification. Check the wiring length and size of the wire. Refer to "Precautions for Correct Use".
☀ Red continuously blinking	Noise or D40Z failure	There may be excessive noise. Check and correct ambient noise environment. There may be a failure in internal circuit. Replace with a new D40Z.
	Fault in power supply input (brown/blue)	Power supply voltage to D40Z may be insufficient. Check the power supply voltage (between brown and blue cables) of D40Z fills ratings. Refer to "Specifications" on page 8. The wiring length or size of the wire may not be to the specification. Check the wiring length and size of the wire. Refer to "Precautions for Correct Use".
☀ Red blinks once for 2s	Fault in Non-contact door switch output (black)	Black line may be shorted to other line. Check and correct wiring of black line if the black line is shorted to other lines. Refer to "Wiring of Inputs and Outputs" on page 11.
☀ Red blinks twice for 2s	Sensing fault	Invalid actuator may be in a close range to switch. Use the dedicated actuator.
☀ Red blinks thrice for 2s	Fault in Non-contact door switch input (white)	Faulty signal may be input to white line. Check and correct wiring of white line. Refer to "Wiring of Inputs and Outputs" on page 11.
☀ Yellow blinking	OFF state of another D40Z	Another D40Z may be in OFF state. Check status of another D40Z connected to the white line and the wiring. Refer to "Switch and Actuator Operation" on page 17 or "Wiring of Inputs and Outputs" on page 11.
	Fault in Non-contact door switch input (white)	White line may be disconnected. Check and correct wiring of white line. Refer to "Wiring of Inputs and Outputs" on page 11.
○ Red Solid-ON #2	Actuator fault	There may be a failure in actuator. Replace with a new D40Z.
○ Yellow Solid-ON #3	Fault in Non-contact door switch input (white)	White line connected to D1 terminal (test output terminal of G9SP) of G9SX-NS□ may be shorted to other line. Check and correct wiring of white line connected to D1 terminal (test output terminal of G9SP) of G9SX-NS□ if the white line is shorted to other lines. Refer to "Wiring of Inputs and Outputs" on page 11.
	Fault in Non-contact door switch output (black)	Black line connected to D2 terminal (safety input terminal of G9SP) of G9SX-NS□ may be disconnected. Check and correct wiring of black line connected to D2 terminal (safety input terminal of G9SP) of G9SX-NS□. Refer to "Wiring of Inputs and Outputs" on page 11.

*1. Another possible cause is a failure in internal circuit. In this case, replace with a new D40Z.

Yet another possible cause is excessive noise. In this case, check and correct ambient noise environment.

*2. The case where the guard door is closed (Switch detects actuator) is indicated.

*3. The case where the system stops though the guard door is closed (Switch detects actuator) is indicated.

D40Z/G9SX-NS/G9SP

Dimensions/Wiring

(Unit: mm)

Non-contact Door Switch

D40Z-1C2

D40Z-1C5

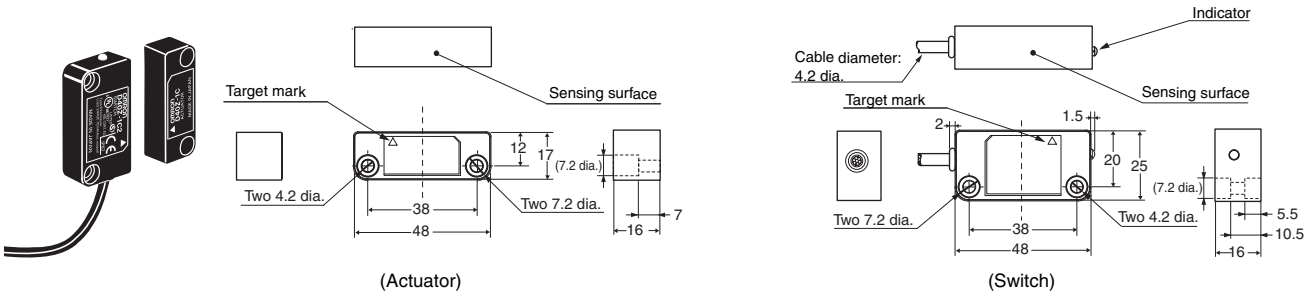

Non-contact Door Switch D40Z and Non-contact Door Switch Controller G9SX-NS□ or Safety Controller G9SP Wiring

Example of connection to G9SX-NS□ (Single connection)

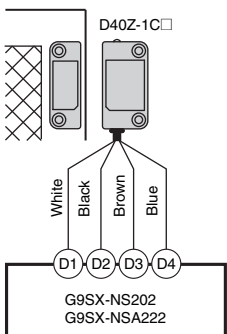

Example of connection to multiple switches

Connect up to 30 Non-contact Door Switches.

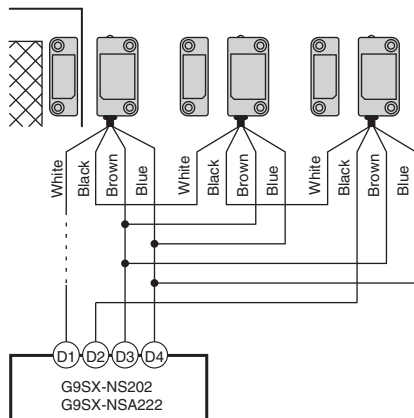

Example of auxiliary outputs

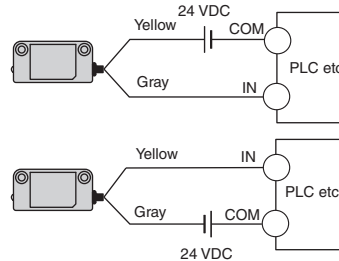

Note: The auxiliary output load current must be 10 mA max. Wrong connection may lead to a failure of the auxiliary output circuit.

Wiring of Inputs and Outputs

Signal name		Cable color	Description of operation
Non-contact Door Switch power supply input	+	Brown	Supplies power to the D40Z.
	-	Blue	
Non-contact door switch input		White	To set non-contact door switch output in ON state, non-contact door switch signal input must be in ON state.
Non-contact door switch output		Black	Output status depends on statuses of actuator and non-contact door switch signal input.
Auxiliary monitoring output		Yellow	Output status depends on status of actuator.
		Gray	When a fault is detected, turns into OFF state regardless of actuator status.

Application Examples

G9SP-N20S(24 VDC) (2-channel Emergency Stop Switch Inputs + Non-contact Door Switch/Manual Reset)

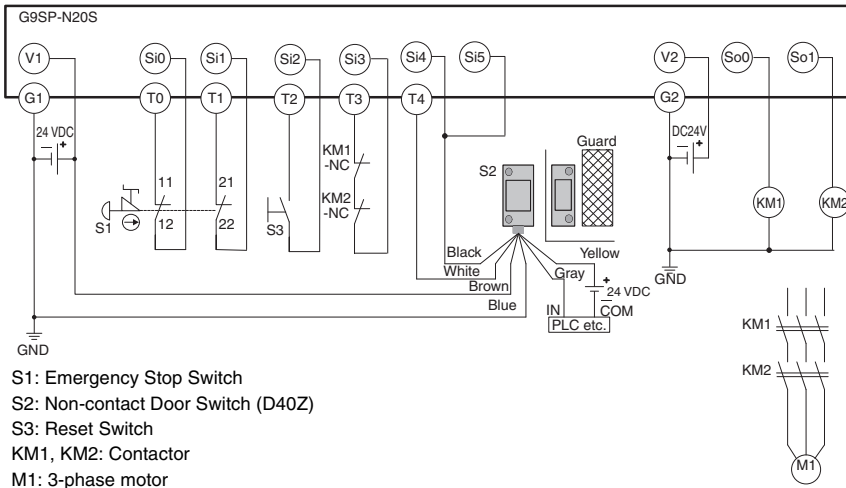

- S1: Emergency Stop Switch
- S2: Non-contact Door Switch (D40Z)
- S3: Reset Switch
- KM1, KM2: Contactor
- M1: 3-phase motor

- Note:**
1. The PL and category that correspond to this circuit example vary depending on the program configured to the G9SP-N20S. For details, refer to "G9SP Series User's Manual (Cat.No.Z922)".
 2. For details on terminal arrangement, refer to "G9SP Series User's Manual (Cat.No.Z922)".
 3. Wire auxiliary outputs correctly. Incorrect wiring may lead to a failure of the auxiliary output circuit.

G9SX-NSA222-T03-□ (24 VDC) (2-channel Emergency Stop Switch Inputs + Non-contact Door Switch/Manual Reset)

PL/safety category	Model	Stop category	Reset
PLe/4 equivalent	Non-contact Door Switch D40Z Non-contact Door Switch Controller G9SX-NSA222-T03-□ (24 VDC)	1	Manual

- Note:**
1. The above PL is only the evaluation result of the example. The PL must be evaluated in an actual application by the customer after confirming the usage conditions.
 2. The above PL is the evaluation result concerning the guard. The PL for emergency stop switch and other safety functions must be separately evaluated.
 3. Stopping time is required between when an opening of the guard is detected and when the motor M stops. Use after risk assessment to prevent operators from approaching hazardous areas too closely during this period.

Application Overview

- The S2 monitors the guard, and stop command is sent to the motor controller when the guard is opened.
- The power supply to the motor M is turned OFF after OFF-delay time.
- The power supply to the motor M is kept OFF while the guard is opened.
- The power supply to the motor M is turned ON again when the reset switch S3 is pressed while the guard is closed.

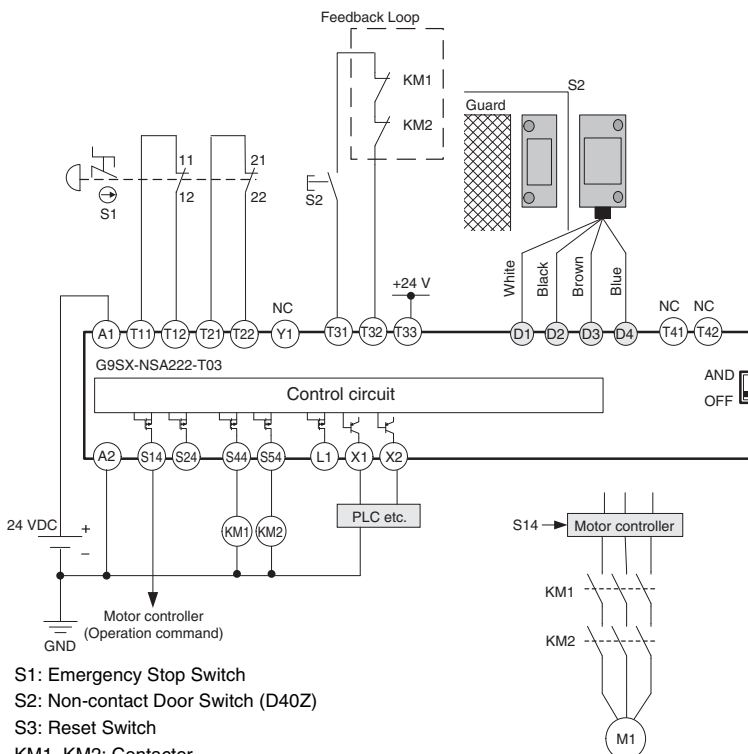

- S1: Emergency Stop Switch
- S2: Non-contact Door Switch (D40Z)
- S3: Reset Switch
- KM1, KM2: Contactor
- M1: 3-phase motor

Note: For details, refer to "Safety Category (ISO 13849-1)" on page 16.

Timing chart

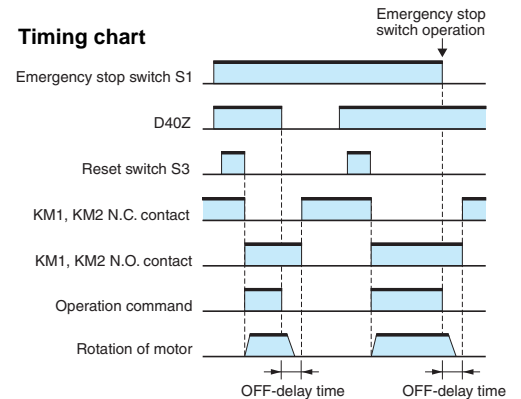

D40Z/G9SX-NS/G9SP

G9SX-BC202 (24 VDC) (2-channel Emergency Stop Switch Inputs/Manual Reset) + G9SX-NS202-□ (24 VDC) (Non-contact Door Switch/Auto Reset)

PL/safety category	Model	Stop category	Reset
PL _e /4 equivalent	Non-contact Door Switch D40Z Non-contact Door Switch Controller G9SX-NSA222-T03-□ (24 VDC)	0	Auto

Note: 1. The above PL is only the evaluation result of the example. The PL must be evaluated in an actual application by the customer after confirming the usage conditions.
2. The above PL is the evaluation result concerning the guard. The PL for emergency stop switch and other safety functions must be separately evaluated.

Application Overview

- The S3 monitors the guard, and the power supply to the motor M2 is turned OFF immediately when the guard is opened.
- The power supply to the motor M2 is kept OFF while the guard is opened.
- The power supply to the motor M2 is turned ON again when the guard is closed.

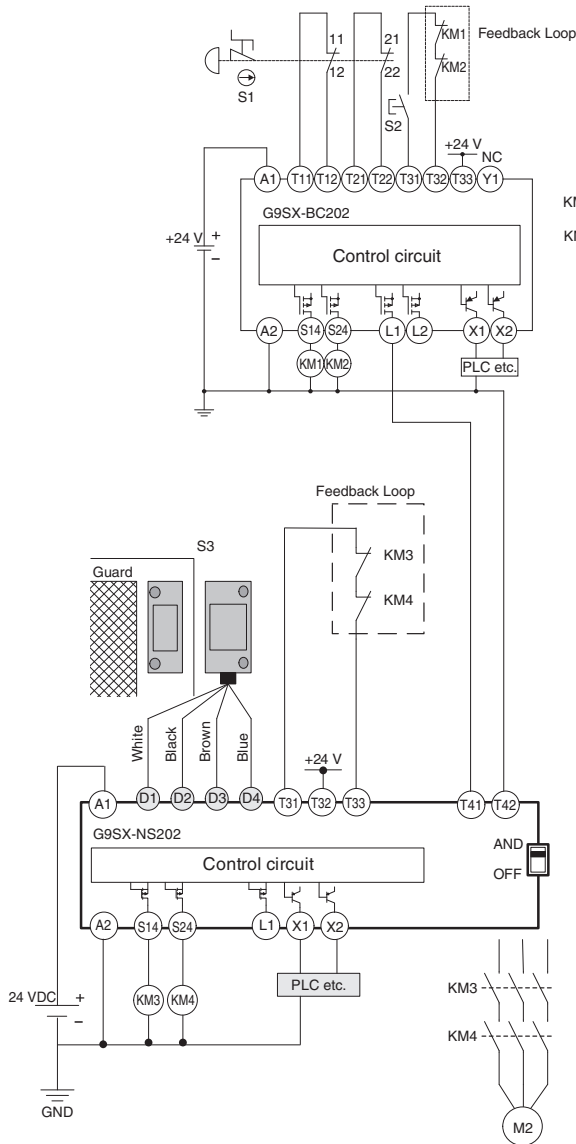

- S1: Emergency Stop Switch
- S2: Reset Switch
- KM1, KM2: Contactor
- M1: 3-phase motor
- S3: Non-contact Door Switch (D40Z)
- KM3, KM4: Contactor
- M2: 3-phase motor

Timing chart

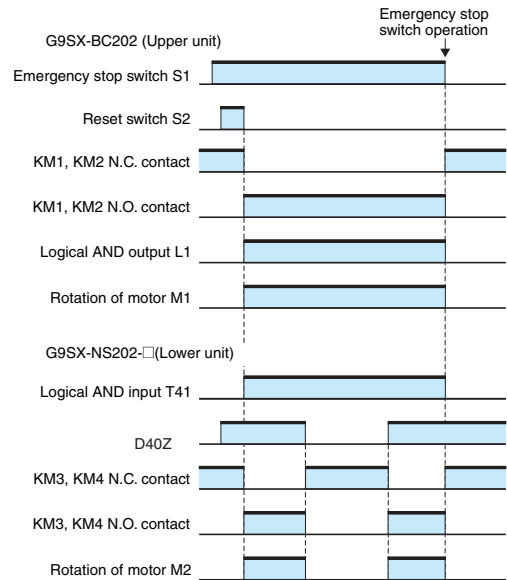

Note: For details, refer to "Safety Category (ISO 13849-1)" on page 16

Safety Precautions

Be sure to read the precautions for **All Safety Door Switches** in the website at:<http://www.ia.omron.com/>.

Indication and Meaning for Safe Use

 WARNING	Indicates a potentially hazardous situation which, if not avoided, will result in minor or moderate injury, or may result in serious injury or death. Additionally there may be significant property damage.
Precautions for Safe Use	Supplementary comments on what to do or avoid doing, to use the product safely.
Precautions for Correct Use	Supplementary comments on what to do or avoid doing, to prevent failure to operate, or undesirable effect on product performance.

 WARNING
--

Serious injury may possibly occur due to breakdown of safety outputs.
Do not connect loads beyond the rated value to the safety outputs.



Serious injury may possibly occur due to loss of required safety functions.
Wire the Edge Controller properly so that supply voltages or voltages for loads do NOT touch the safety outputs accidentally.



Serious injury may possibly occur due to breakdown of safety outputs.
Apply protection circuitry against back electromotive force in case connecting inductive loads to safety outputs.



Serious injury may possibly occur due to loss of required safety functions.
Use appropriate devices referring to the following table.



The machine may start operating and may result in serious injury or death. Do not put the actuator close to the switch when the door is open.



Control device	Requirements
Emergency Stop Switch	Use approved device with direct opening mechanism complying with IEC/EN 60947-5-1.
Safety Door Switch, Safety Limit Switch	Use approved device with direct opening mechanism complying with IEC/EN 60947-5-1 and capable of switching micro loads of 24 VDC, 5 mA.
Non-contact Door Switch	The G9SX-NS must be used with D40Z Non-contact Door Switches.
Relay with forcibly guided contacts	Use approved devices with forcibly guided contacts complying with EN 50205. For feedback, use devices with contacts capable of switching micro loads of 24 VDC, 5 mA.
Contactor	Use contactors with forcibly guided mechanism to input the signal to the Feedback/Reset input of the G9SX-NS through the NC contact of the contactor. For feedback, use devices with contacts capable of switching micro loads of 24 VDC, 5 mA. Failure to open contacts of a contactor cannot be detected by connecting NC contact of the contactor without a forcibly guided mechanism to the Feedback/Reset input.
Other devices	Evaluate whether devices used are appropriate to satisfy the requirements of the safety category level.

Precautions for Safe Use

1. Disconnect the G9SX-NS from the power supply when wiring the D40Z. Devices connected to the product may operate unexpectedly.
2. Do not operate the product in atmospheres containing flammable or explosive gas.
3. Wire conductors correctly and verify the operation of the product before using the system in which the product is incorporated. Incorrect wiring may lead to loss of safety functions.
4. Auxiliary monitoring outputs are NOT safety outputs. Do not use auxiliary monitoring outputs as safety outputs. Such incorrect use will cause loss of safety function of D40Z and peripheral devices.
5. After installing the D40Z, qualified personnel must confirm the installation, and must conduct test operations and maintenance. The qualified personnel must be qualified and authorized to secure safety at each phases of design, installation, running, maintenance, and disposal of the system.
6. A qualified person in charge, who is familiar with the machine in which the D40Z is to be installed, must conduct and verify the installation.
7. Be sure to inspect the D40Z daily and every 6 months. Otherwise, serious injury may possibly occur due to system malfunctions.
8. Do not dismantle, repair, or modify the product. Doing so may lead to loss of safety functions.
9. Do not apply DC voltages exceeding the rated voltages, nor any AC voltages to D40Z.
10. Use a DC supply satisfying the requirements given below to prevent electric shock.
 - A DC power supply with double or reinforced insulation, for example, according to IEC/EN 60950 or EN 50178, or a transformer according to IEC/EN 61558.
 - A DC supply satisfying the requirements for class 2 circuits or limited voltage/current circuits stated in UL 508.
11. Connect the D40Z to only appropriate components or devices complying with relevant safety standards corresponding to the required level of safety category. Conformity to requirements of the safety category must be determined for the entire system. It is recommended to consult an authorized certification body regarding assessment of conformity to the required safety level.

Precautions for Correct Use

1. The D40Z must be used with a designated actuator and controller to comply with EN ISO 13849-1.
2. Handle with care
Do not drop the product or expose it to excessive vibration or mechanical shock. The product may be damaged and may not function properly.
3. Storage and operating conditions
Do not store or use the products under the following conditions.
 1. In direct sunlight
 2. At ambient temperatures not between -10 and 65°C
 3. At relative humidity not between 25% and 85%
 4. In corrosive or combustible gases
 5. Where subject to vibration or mechanical shock beyond the rated values
 6. Where subject to contact with oil or chemicals
 7. In an atmosphere containing excessive dust, saline, or metal powder
 8. Where iron filings or powder may fall on the product
4. Do not use D40Z at altitudes over 1,000 meters.
5. Do not use to connect other switches or sensors to the wire conductors of D40Z.
6. Disconnect D40Z and the controller connected to D40Z from power supply when replacing D40Z. Failure to do so may cause unexpected operation of devices connected to D40Z.
7. Keep D40Z from solvent such as alcohol, thinner, trichloroethane or gasoline. Such solvents make the marking on D40Z illegible and cause deterioration of parts.
8. Do not use D40Z in the magnetic field of 1.5 mT or more, otherwise D40Z may not function properly.
9. Do not use D40Z in the water or continuous water exposure environment, otherwise water may leak into D40Z. (An enclosure of IP67 rating, which D40Z is rated, protects against temporary immersion in water.)
10. Do not use D40Z switch or actuator as a stopper. Use a stopper to protect the switch and the actuator. Keep a distance of at least 1 mm between the switch and the actuator.
11. Be sure to install D40Z switch and actuator in such as appropriate distance that does not create a gap accessible to the hazard.

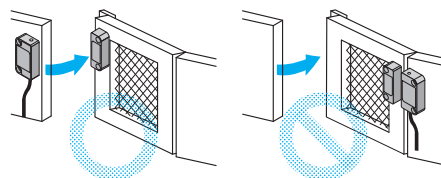

12. When installing two or more adjacent switches, keep a distance of at least 50 mm from one another.

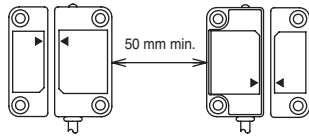

13. Be sure that the machine is stopped whenever the guard door is open.

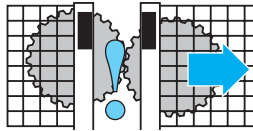

14. Mounting the switch and actuator on metal may affect the operating distance. If there are nearby devices that generate strong radio waves or magnetic fields, they may also affect the operating distance through the metal. Do not mount the switch and actuator directly on metal.

When installing them on a metallic material, be sure to verify such an effect before using. Refer to the following table for the estimated effects of mounting on metal on the operating distance.

Type of metal	Operating distance
Iron	Approx. 75% of normal distance
Aluminum	Approx. 85% of normal distance
Stainless steel	Approx. 85% of normal distance

We recommend that you separate the switch and actuator at least 10 mm from all nearby metal.

15. Use M4 screws with a maximum diameter of 7mm and washers to install the switch and actuator. Tighten the screws with a specified torque. After installing and commissioning, coat the switch-actuator fixing screws with tamper-proof varnish or similar compound for locking. Using anaerobic locking compounds can have a detrimental effect on the plastic switch case if the compounds contact with the switch case.

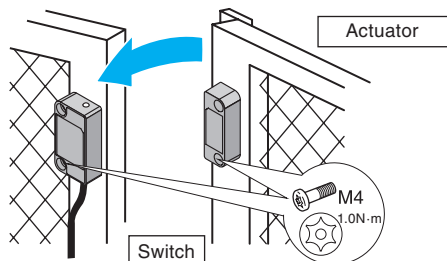

16. Wiring

1. Stranded wire : 0.2 to 2.5 mm AWG24 to AWG12
Solid wire : 0.2 to 2.5 mm AWG24 to AWG12
2. When not using auxiliary output, cut off the unused conductors and protect by insulating-taping to prevent contacting with other terminals.
3. When you use an additional cable of 20 m or longer, use a multiconductor cable to group the white, black, brown, and blue lines together.

17. Use cables of a total length of 100 m max. to connect multiple D40Z switches. However, the total length of 200 m max. is possible depending on the number of D40Z switches connected. The supply voltage to D40Z may decrease by the voltage drop depending on the cable or the wiring configuration. Check the power-supply voltage is in the rated range.

30 or less D40Z connected 15 or less D40Z connected

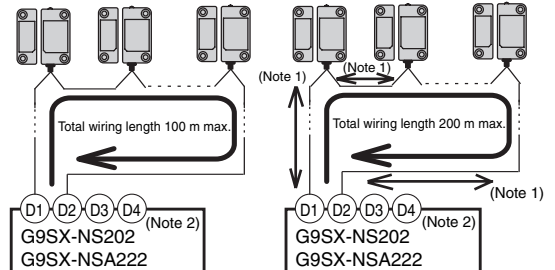

Note 1. The wiring length between the products must be 100 m max.

Note 2. For details on connection terminal and wiring of G9SP, refer to the G9SP Manual (Cat.No.Z922).

18. D40Z is a class A product. In residential areas D40Z may cause radio interference, in which case the user may be required to take adequate measures to reduce interference.
19. D40Z may not function properly in surrounding environment with strong electromagnetic equipment such as RFID system, proximity sensor, motor, inverter, and switching power supply. If you use D40Z near such equipment, be sure to verify effects of such equipment on D40Z before using.
20. Handle cables with care:
1. For bending cables, it is recommended to bend them with a radius of bend no less than six times the cable outer diameter.
 2. Do not apply a tensile strength of 50N or greater to the cables.
21. To determine safety distance to hazards, take into account the delay of non-contact door switch output caused the response time.
22. If there is any machine that has a large surge current (e.g., a motor) near D40Z, connected a surge absorber to D40Z between the blue and the other cables (white, black and brown) respectively, or between the yellow cable and gray cable. Suggested surge absorber's specification is as follows:
- Peak pulse power: 600 W (10/1000 μs) or more (Per IEC 61000-4-5 (surge immunity))
 - Breakdown voltage: 27-33 V

Switch and Actuator Operation

Switch and Actuator Mounting Directions

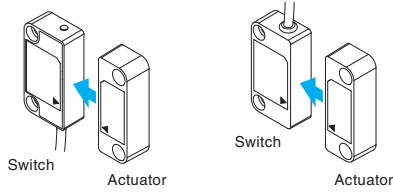

Switch and actuator operating directions

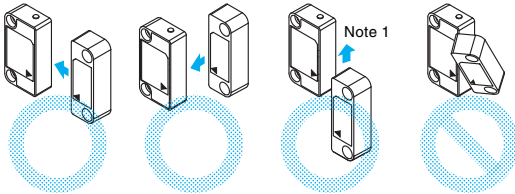

Note 1. When using the operating direction along the sensing surface, be sure to provide a gap of at least 3 mm between the switch and actuator to eliminate the effects of the side lobes.

Safety Category (ISO 13849-1)

When used in combination with the G9SP or G9SX-NS□, the D40Z can be used for the environments corresponding to performance level e and safety category 4 as required by EN ISO 13849-1.

The settings are determined by circuit examples provided by OMRON, however, and may not be applicable depending on the operating conditions. Performance levels and safety categories are determined for the safety control system as a whole. You must confirm conformity for the entire system.

Approved Standards

- EN ISO 13849-1: 2008 PL_e/Safety Category 4 (used with G9SX-NS□)
- IEC/EN 61508 SIL 3 (used with G9SX-NS□)
- IEC/EN 60947-5-3 PDF-M (used with G9SX-NS□)
- UL 508
- CAN/CSA C22.2 No.14

Terms and Conditions of Sale

1. **Offer; Acceptance.** These terms and conditions (these "**Terms**") are deemed part of all quotes, agreements, purchase orders, acknowledgments, price lists, catalogs, manuals, brochures and other documents, whether electronic or in writing, relating to the sale of products or services (collectively, the "**Products**") by Omron Electronics LLC and its subsidiary companies ("**Omron**"). Omron objects to any terms or conditions proposed in Buyer's purchase order or other documents which are inconsistent with, or in addition to, these Terms.
2. **Prices; Payment Terms.** All prices stated are current, subject to change without notice by Omron. Omron reserves the right to increase or decrease prices on any unshipped portions of outstanding orders. Payments for Products are due net 30 days unless otherwise stated in the invoice.
3. **Discounts.** Cash discounts, if any, will apply only on the net amount of invoices sent to Buyer after deducting transportation charges, taxes and duties, and will be allowed only if (i) the invoice is paid according to Omron's payment terms and (ii) Buyer has no past due amounts.
4. **Interest.** Omron, at its option, may charge Buyer 1-1/2% interest per month or the maximum legal rate, whichever is less, on any balance not paid within the stated terms.
5. **Orders.** Omron will accept no order less than \$200 net billing.
6. **Governmental Approvals.** Buyer shall be responsible for, and shall bear all costs involved in, obtaining any government approvals required for the importation or sale of the Products.
7. **Taxes.** All taxes, duties and other governmental charges (other than general real property and income taxes), including any interest or penalties thereon, imposed directly or indirectly on Omron or required to be collected directly or indirectly by Omron for the manufacture, production, sale, delivery, importation, consumption or use of the Products sold hereunder (including customs duties and sales, excise, use, turnover and license taxes) shall be charged to and remitted by Buyer to Omron.
8. **Financial.** If the financial position of Buyer at any time becomes unsatisfactory to Omron, Omron reserves the right to stop shipments or require satisfactory security or payment in advance. If Buyer fails to make payment or otherwise comply with these Terms or any related agreement, Omron may (without liability and in addition to other remedies) cancel any unshipped portion of Products sold hereunder and stop any Products in transit until Buyer pays all amounts, including amounts payable hereunder, whether or not then due, which are owing to it by Buyer. Buyer shall in any event remain liable for all unpaid accounts.
9. **Cancellation; Etc.** Orders are not subject to rescheduling or cancellation unless Buyer indemnifies Omron against all related costs or expenses.
10. **Force Majeure.** Omron shall not be liable for any delay or failure in delivery resulting from causes beyond its control, including earthquakes, fires, floods, strikes or other labor disputes, shortage of labor or materials, accidents to machinery, acts of sabotage, riots, delay in or lack of transportation or the requirements of any government authority.
11. **Shipping; Delivery.** Unless otherwise expressly agreed in writing by Omron:
 - a. Shipments shall be by a carrier selected by Omron; Omron will not drop ship except in "break down" situations.
 - b. Such carrier shall act as the agent of Buyer and delivery to such carrier shall constitute delivery to Buyer;
 - c. All sales and shipments of Products shall be FOB shipping point (unless otherwise stated in writing by Omron), at which point title and risk of loss shall pass from Omron to Buyer; provided that Omron shall retain a security interest in the Products until the full purchase price is paid;
 - d. Delivery and shipping dates are estimates only; and
 - e. Omron will package Products as it deems proper for protection against normal handling and extra charges apply to special conditions.
12. **Claims.** Any claim by Buyer against Omron for shortage or damage to the Products occurring before delivery to the carrier must be presented in writing to Omron within 30 days of receipt of shipment and include the original transportation bill signed by the carrier noting that the carrier received the Products from Omron in the condition claimed.
13. **Warranties.** (a) **Exclusive Warranty.** Omron's exclusive warranty is that the Products will be free from defects in materials and workmanship for a period of twelve months from the date of sale by Omron (or such other period expressed in writing by Omron). Omron disclaims all other warranties, express or implied. (b) **Limitations.** OMRON MAKES NO WARRANTY OR REPRESENTATION, EXPRESS OR IMPLIED, ABOUT NON-INFRINGEMENT, MERCHANTABILITY OR FITNESS FOR A PARTICULAR PURPOSE OF THE PRODUCTS. BUYER ACKNOWLEDGES THAT IT ALONE HAS DETERMINED THAT THE PRODUCTS WILL SUITABLY MEET THE REQUIREMENTS OF THEIR INTENDED USE. Omron further disclaims all warranties and responsibility of any type for claims or expenses based on infringement by the Products or otherwise of any intellectual property right. (c) **Buyer Remedy.** Omron's sole obligation hereunder shall be, at Omron's election, to (i) replace (in the form originally shipped with Buyer responsible for labor charges for removal or replacement thereof) the non-complying Product, (ii) repair the non-complying Product, or (iii) repay or credit Buyer an amount equal to the purchase price of the non-complying Product; provided that in no event shall Omron be responsible for warranty, repair, indemnity or any other claims or expenses regarding the Products unless Omron's analysis confirms that the Products were properly handled, stored, installed and maintained and not subject to contamination, abuse, misuse or inappropriate modification. Return of any Products by Buyer must be approved in writing by Omron before shipment. Omron Companies shall not be liable for the suitability or unsuitability or the results from the use of Products in combination with any electrical or electronic components, circuits, system assemblies or any other materials or substances or environments. Any advice, recommendations or information given orally or in writing, are not to be construed as an amendment or addition to the above warranty. See <http://www.omron247.com> or contact your Omron representative for published information.
14. **Limitation on Liability; Etc.** OMRON COMPANIES SHALL NOT BE LIABLE FOR SPECIAL, INDIRECT, INCIDENTAL, OR CONSEQUENTIAL DAMAGES, LOSS OF PROFITS OR PRODUCTION OR COMMERCIAL LOSS IN ANY WAY CONNECTED WITH THE PRODUCTS, WHETHER SUCH CLAIM IS BASED IN CONTRACT, WARRANTY, NEGLIGENCE OR STRICT LIABILITY. Further, in no event shall liability of Omron Companies exceed the individual price of the Product on which liability is asserted.
15. **Indemnities.** Buyer shall indemnify and hold harmless Omron Companies and their employees from and against all liabilities, losses, claims, costs and expenses (including attorney's fees and expenses) related to any claim, investigation, litigation or proceeding (whether or not Omron is a party) which arises or is alleged to arise from Buyer's acts or omissions under these Terms or in any way with respect to the Products. Without limiting the foregoing, Buyer (at its own expense) shall indemnify and hold harmless Omron and defend or settle any action brought against such Companies to the extent based on a claim that any Product made to Buyer specifications infringed intellectual property rights of another party.
16. **Property; Confidentiality.** Any intellectual property in the Products is the exclusive property of Omron Companies and Buyer shall not attempt to duplicate it in any way without the written permission of Omron. Notwithstanding any charges to Buyer for engineering or tooling, all engineering and tooling shall remain the exclusive property of Omron. All information and materials supplied by Omron to Buyer relating to the Products are confidential and proprietary, and Buyer shall limit distribution thereof to its trusted employees and strictly prevent disclosure to any third party.
17. **Export Controls.** Buyer shall comply with all applicable laws, regulations and licenses regarding (i) export of products or information; (ii) sale of products to "forbidden" or other proscribed persons; and (iii) disclosure to non-citizens of regulated technology or information.
18. **Miscellaneous.** (a) **Waiver.** No failure or delay by Omron in exercising any right and no course of dealing between Buyer and Omron shall operate as a waiver of rights by Omron. (b) **Assignment.** Buyer may not assign its rights hereunder without Omron's written consent. (c) **Law.** These Terms are governed by the law of the jurisdiction of the home office of the Omron company from which Buyer is purchasing the Products (without regard to conflict of law principles). (d) **Amendment.** These Terms constitute the entire agreement between Buyer and Omron relating to the Products, and no provision may be changed or waived unless in writing signed by the parties. (e) **Severability.** If any provision hereof is rendered ineffective or invalid, such provision shall not invalidate any other provision. (f) **Setoff.** Buyer shall have no right to set off any amounts against the amount owing in respect of this invoice. (g) **Definitions.** As used herein, "including" means "including without limitation"; and "Omron Companies" (or similar words) mean Omron Corporation and any direct or indirect subsidiary or affiliate thereof.

Certain Precautions on Specifications and Use

1. **Suitability of Use.** Omron Companies shall not be responsible for conformity with any standards, codes or regulations which apply to the combination of the Product in the Buyer's application or use of the Product. At Buyer's request, Omron will provide applicable third party certification documents identifying ratings and limitations of use which apply to the Product. This information by itself is not sufficient for a complete determination of the suitability of the Product in combination with the end product, machine, system, or other application or use. Buyer shall be solely responsible for determining appropriateness of the particular Product with respect to Buyer's application, product or system. Buyer shall take application responsibility in all cases but the following is a non-exhaustive list of applications for which particular attention must be given: (i) Outdoor use, uses involving potential chemical contamination or electrical interference, or conditions or uses not described in this document. (ii) Use in consumer products or any use in significant quantities. (iii) Energy control systems, combustion systems, railroad systems, aviation systems, medical equipment, amusement machines, vehicles, safety equipment, and installations subject to separate industry or government regulations. (iv) Systems, machines and equipment that could present a risk to life or property. Please know and observe all prohibitions of use applicable to this Product. NEVER USE THE PRODUCT FOR AN APPLICATION INVOLVING SERIOUS RISK TO LIFE OR PROPERTY OR IN LARGE QUANTITIES WITHOUT ENSURING THAT THE SYSTEM AS A WHOLE HAS BEEN DESIGNED TO ADDRESS THE RISKS, AND THAT THE OMRON'S PRODUCT IS PROPERLY RATED AND INSTALLED FOR THE INTENDED USE WITHIN THE OVERALL EQUIPMENT OR SYSTEM.
2. **Programmable Products.** Omron Companies shall not be responsible for the user's programming of a programmable Product, or any consequence thereof.
3. **Performance Data.** Data presented in Omron Company websites, catalogs and other materials is provided as a guide for the user in determining suitability and does not constitute a warranty. It may represent the result of Omron's test conditions, and the user must correlate it to actual application requirements. Actual performance is subject to the Omron's Warranty and Limitations of Liability.
4. **Change in Specifications.** Product specifications and accessories may be changed at any time based on improvements and other reasons. It is our practice to change part numbers when published ratings or features are changed, or when significant construction changes are made. However, some specifications of the Product may be changed without any notice. When in doubt, special part numbers may be assigned to fix or establish key specifications for your application. Please consult with your Omron's representative at any time to confirm actual specifications of purchased Product.
5. **Errors and Omissions.** Information presented by Omron Companies has been checked and is believed to be accurate; however, no responsibility is assumed for clerical, typographical or proofreading errors or omissions.

OMRON AUTOMATION AND SAFETY • THE AMERICAS HEADQUARTERS • Chicago, IL USA • 847.843.7900 • 800.556.6766 • www.omron247.com

OMRON CANADA, INC. • HEAD OFFICE

Toronto, ON, Canada • 416.286.6465 • 866.986.6766 • www.omron247.com

OMRON ELECTRONICS DE MEXICO • HEAD OFFICE

México DF • 52.55.59.01.43.00 • 01-800-226-6766 • mela@omron.com

OMRON ELECTRONICS DE MEXICO • SALES OFFICE

Apodaca, N.L. • 52.81.11.56.99.20 • 01-800-226-6766 • mela@omron.com

OMRON ELETRÔNICA DO BRASIL LTDA • HEAD OFFICE

São Paulo, SP, Brasil • 55.11.2101.6300 • www.omron.com.br

OMRON ARGENTINA • SALES OFFICE

Cono Sur • 54.11.4783.5300

OMRON CHILE • SALES OFFICE

Santiago • 56.9.9917.3920

OTHER OMRON LATIN AMERICA SALES

54.11.4783.5300

OMRON EUROPE B.V. • Wegalaan 67-69, NL-2132 JD, Hoofddorp, The Netherlands. • +31 (0) 23 568 13 00 • www.industrial.omron.eu

Authorized Distributor:

Automation Control Systems

- Machine Automation Controllers (MAC) • Programmable Controllers (PLC)
- Operator interfaces (HMI) • Distributed I/O • Software

Drives & Motion Controls

- Servo & AC Drives • Motion Controllers & Encoders

Temperature & Process Controllers

- Single and Multi-loop Controllers

Sensors & Vision

- Proximity Sensors • Photoelectric Sensors • Fiber-Optic Sensors
- Amplified Photomicrosensors • Measurement Sensors
- Ultrasonic Sensors • Vision Sensors

Industrial Components

- RFID/Code Readers • Relays • Pushbuttons & Indicators
- Limit and Basic Switches • Timers • Counters • Metering Devices
- Power Supplies

Safety

- Laser Scanners • Safety Mats • Edges and Bumpers • Programmable Safety Controllers • Light Curtains • Safety Relays • Safety Interlock Switches