

DESCRIPTION

The DC1508B programming board contains the circuitry needed to program and verify the EEPROM of the [LTC2974](#), [LTC2975](#), [LTC2977](#), [LTC2978](#), and [LTC2978A](#). This is its sole purpose. The DC1508B is shipped with a clamshell style programming socket installed. The EEPROM contains the factory default configuration. The LTpowerPlay™*.proj file that corresponds to the factory default can be found in the GUI.

To properly program and verify the contents of the EEPROM, download and install the LTpowerPlay software (GUI).

<http://www.linear.com/ltpowerplay/>

You also need a Linear Technology DC1613 USB to I²C/SMBus/PMBus Controller.

DEMO SYSTEM REQUIRED HARDWARE

- Windows PC
- USB-to-I²C/SMBus/PMBus Controller (DC1613)
- DC1508B-A or DC1508B-B

DEMO SYSTEM REQUIRED SOFTWARE

- LTpowerPlay

Power System Manager Features

- Sequence, Trim, Margin, Supervise Power Supplies
- Manage Faults, Monitor Telemetry, Create Fault Logs
- PMBus Compliant Command Set
- Supported by LTpowerPlay GUI
- Margin or Trim Supplies to ±0.25% Accuracy
- Fast OV/UV Supervisors per Channel
- Supports Multichannel Fault Management
- Automatic Fault Logging to Internal EEPROM
- Operates Autonomously without Additional SW
- OV/UV V_{OUT} and One V_{IN} Supervisor
- Telemetry Reads Back V_{IN}, V_{OUT}, and Temperature
- Time-Based Output Sequencer
- I²C/SMBus Serial Interface
- All Devices Available in 64-lead QFN Package

Design files for this circuit board are available at
<http://www.linear.com/demo/DC1508B>

LT, LT, LTC, LTM, Linear Technology and the Linear logo are registered trademarks and LTpowerPlay is a trademark of Linear Technology Corporation. All other trademarks are the property of their respective owners.

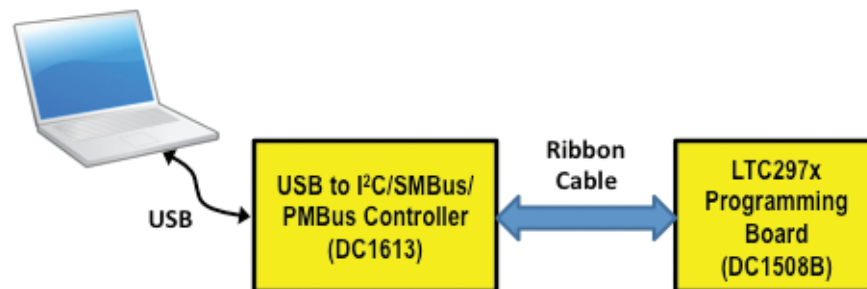

Figure 1. LTC297x Programming Setup Using DC1508B

BOARD PHOTO

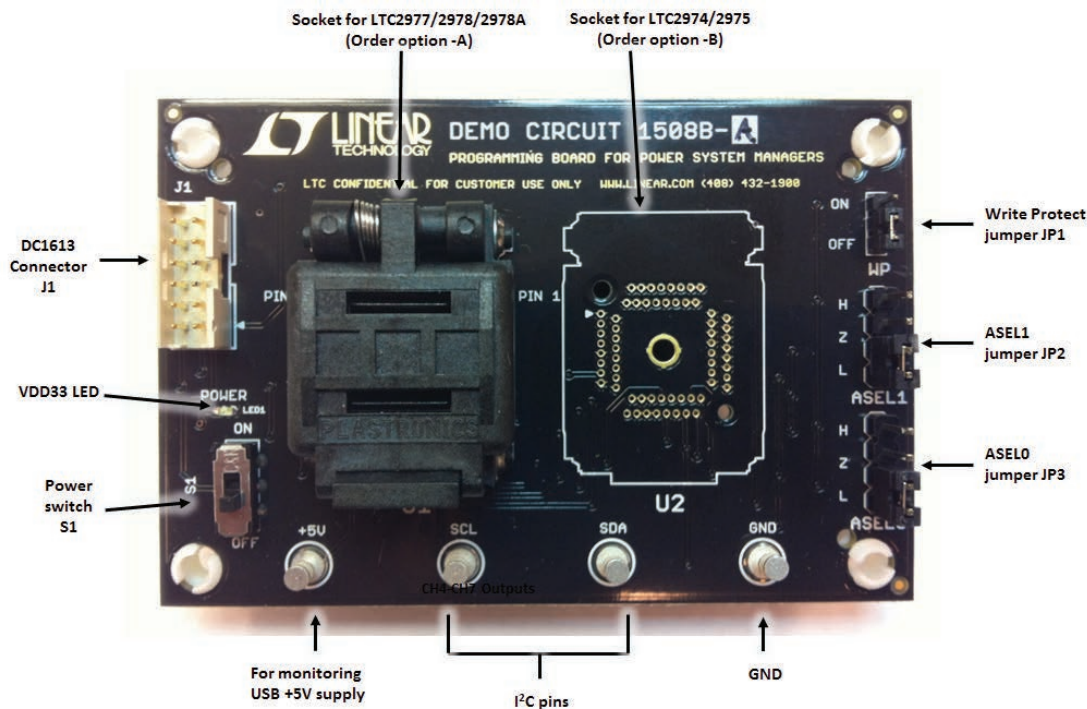

Figure 2. DC1508B Top Side Details (DC1508B-A Shown)

ORDER INFORMATION

There are two versions of the DC1508B. Each version of the programming board comes with only one socket. See Table 1.

Table 1.

Order Number	Supported Devices
DC1508B-A	LTC2977, LTC2978, LTC2978A
DC1508B-B	LTC2974, LTC2975

LTPOWERPLAY GUI SOFTWARE

LTpowerPlay is a powerful Windows-based development environment that supports Linear Technology Power System Management ICs with EEPROM. The software supports a variety of different tasks. You can use LTpowerPlay to evaluate Linear Technology ICs by connecting to a demo board system. LTpowerPlay can also be used in an offline mode (with no hardware present) in order to build a multichip configuration file that can be saved and

reloaded at a later time. LTpowerPlay provides unprecedented diagnostic and debug features. It becomes a valuable diagnostic tool during board bring-up to program or tweak the power management scheme in a system or to diagnose power issues when bringing up rails. LTpowerPlay utilizes the DC1613 I²C/SMBus/PMBus Controller to communicate with one of many potential targets, including the DC1508B programming board or a customer board.

LTPOWERPLAY GUI SOFTWARE

The software also provides an automatic update feature to keep the software current with the latest set of device drivers and documentation. The LTpowerPlay software can be downloaded from:

<http://www.linear.com/ltpowerplay>

To access technical support documents for LTC Power System Management products visit Help, View Online Help on the LTpowerPlay menu.

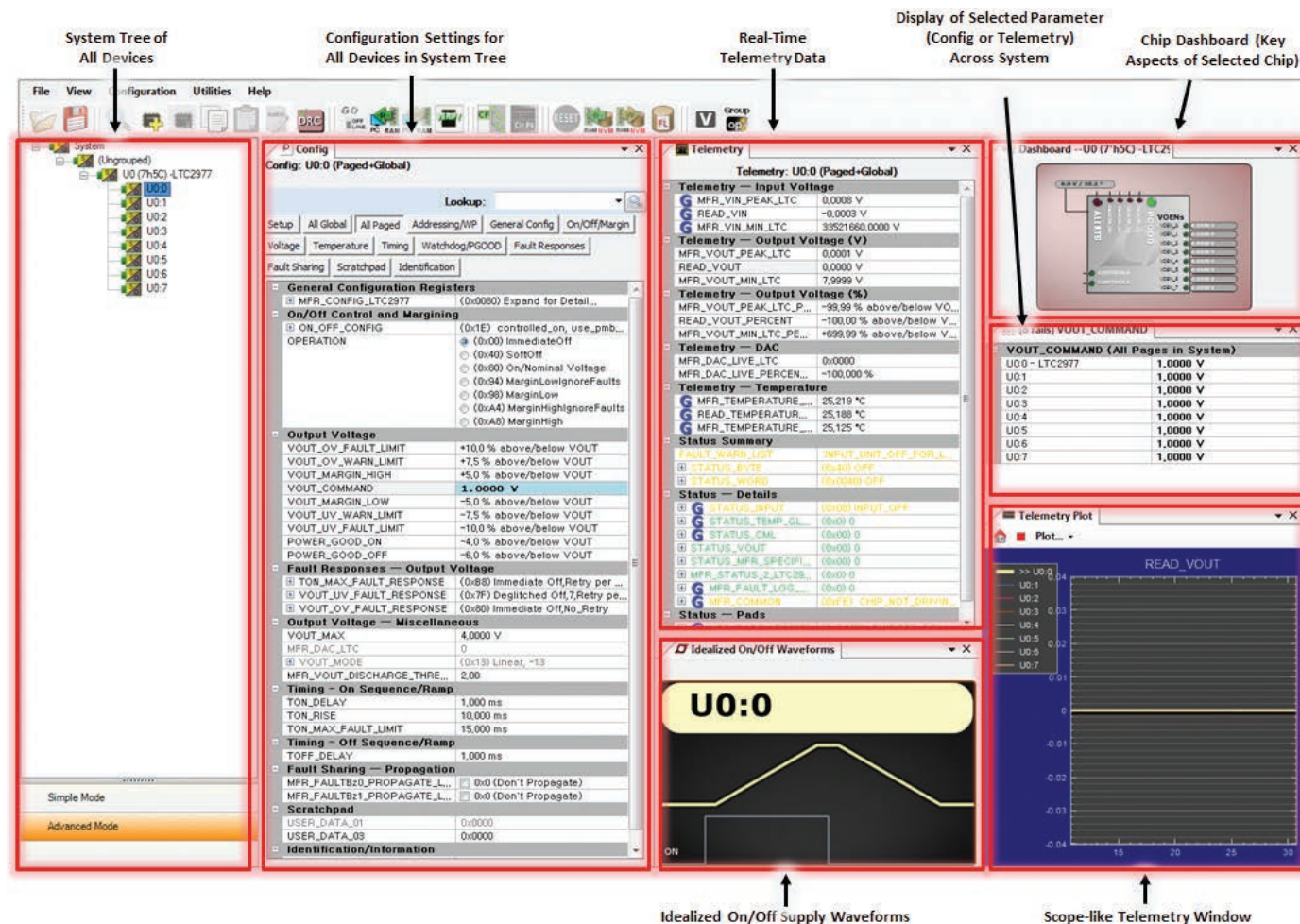

Figure 3. Screenshot of the LTpowerPlay GUI

DEMO MANUAL DC1508B

QUICK START PROCEDURE

The DC1508B programming board makes it easy to program and verify the EEPROM contents of the device.

1. Place jumpers and switches in the following default positions.

WP: OFF
ASEL1: L
ASEL0: L
S1: OFF

NOTE: By default, the ASEL jumpers are both set to low. If you wish to program a device with an offset address other than 0x5C, adjust the ASEL jumpers appropriately. Consult device data sheet for details.

2. Connect the DC1613 controller to your PC. Plug the ribbon cable into connector J1 of the DC1508B programming board.
3. Open the socket lid. Place the IC inside with pin 1 located in the upper left corner. See Figure 4.

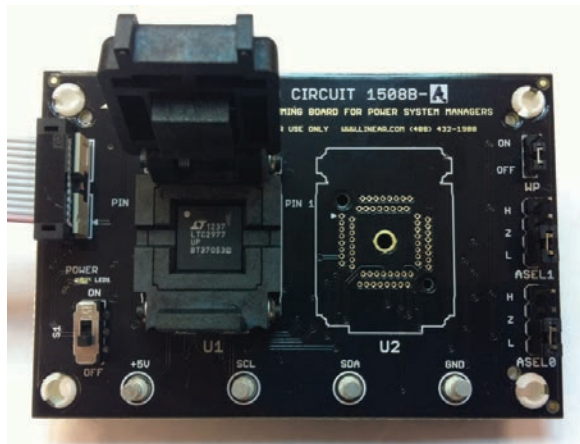

Figure 4. Open Clamshell Lid

4. Close lid. It will snap into place. See Figure 5.

NOTE: Removal and insertion of the IC should be done with either tweezers or a vacuum suction device, and also with the power switch S1 set to OFF.

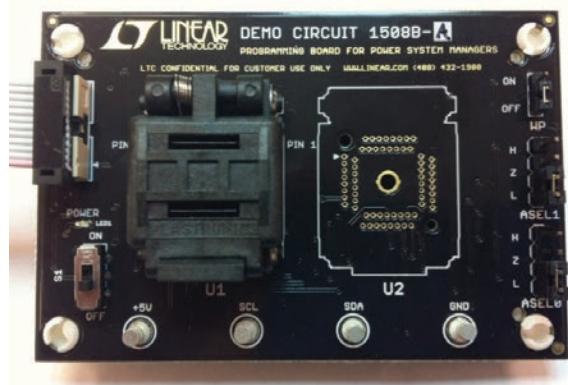
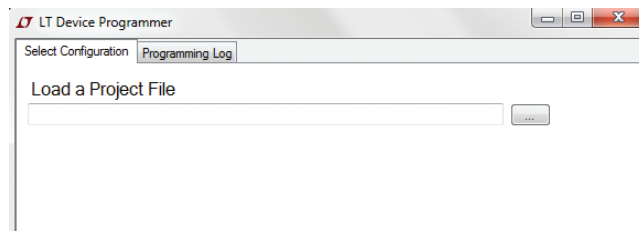
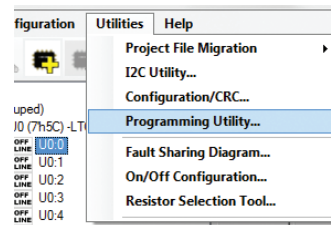

Figure 5. DC1613 Ribbon Cable Attached and Lid Closed

5. Set the power switch S1 to the ON position. The VDD33 LED will illuminate, indicating the on-chip regulator is providing internal power.
6. Launch the LTpowerPlay software from your PC. Select Utilities>Programming Utility from the menu. Click “...” next to the selection box and select a .proj file to program the device.



QUICK START PROCEDURE

7. LTpowerPlay is ready to program/verify the device.
 - a. Click the Program and Verify button, and wait for the process to complete.

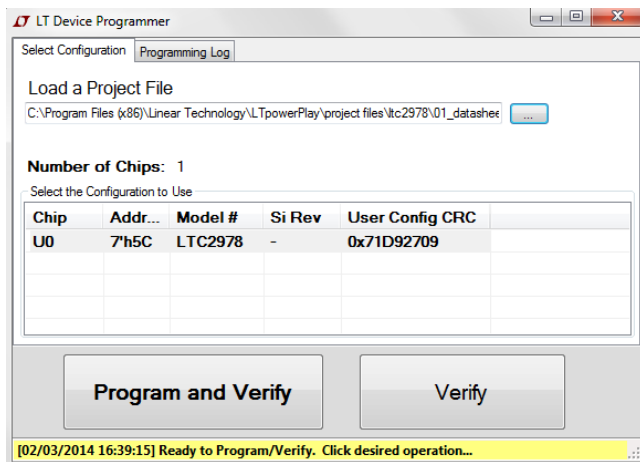

- b. After the process is complete, you will see Successfully Programmed and Verified Device in the status bar at the bottom.

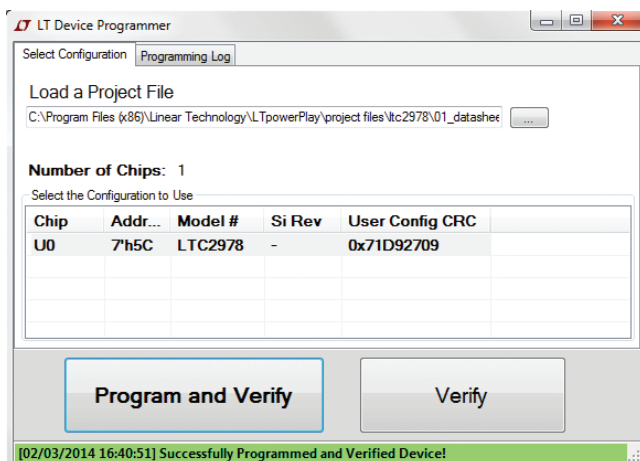

8. Prior to removing the device and programming another, power must be removed from the device. Set the power switch S1 to the OFF position. Open the socket lid. Remove the device with tweezers or a vacuum tool. The USB ribbon cable may remain connected to the programming board.
9. To program another device, repeat Steps 3 through 5, then Steps 7 and 8. LTpowerPlay's Programming Utility does not need to be closed.

DEMO MANUAL DC1508B

PARTS LIST

ITEM	QTY	REFERENCE	PART DESCRIPTION	MANUFACTURER/PART NUMBER
Required Circuit Components				
1	1	U1 (DC1508B-A) or U2 (DC1508B-B)	IC SOCKET, SPRING LOADED, 64-QFN	PLASTRONICS: 64QN50S19090-A
2	3	C1, C2, C7	CAP CER 1 μ F 16V 10% X7R 0603	MURATA: GRM188R71C105KA12D
3	8	C3, C4, C5, C6, C8, C9, C10, C11	CAP CER 0.1 μ F 16V 10% X7R 0603	MURATA: GRM188R71C104KA01D
4	1	J1	CONN HEADER 12POS 2mm STR DL PCB	FCI: 98414-G06-12ULF
5	1	JP1	CONN HEADER 0.100 INCH 1X3POS	WÜRTH: 613 003 111 21
6	2	JP2, JP3	CONN HEADER 0.100 INCH 1X4POS	WÜRTH: 613 004 111 21
7	1	LED1	LED GREEN HIGH BRIGHT ESS SMD	PANASONIC: LNJ326W83RA
8	4	MH1, MH2, MH3, MH4	STAND-OFF NYLON 1/4" SNAP IN	WÜRTH: 702 931 000
9	5	R1, R2, R4, R7, R8	RES 10.0k 1/10W 1% 0603 SMD	YAGEO: RC0603FR-0710KL
10	1	R3	RES 1.3k 1/10W 1% 0603 SMD	YAGEO: RC0603JR-071K3L
11	0	R5, R6 (OPTIONAL)	RES 10.0k 1/10W 1% 0603 SMD	
12	3	SH1, SH2, SH3	CONN SHUNT 0.1IN 2POS BLACK	WÜRTH: 609 002 134 21
13	1	S1	SW SLIDE DPDT 6VDC 0.3A PCMNT	C&K: JS202011CQN
14	4	TP1, TP2, TP3, TP4	TERM SOLDER TURRET 0.219" 0.078"L	MILL-MAX: 2501-2-00-80-00-00-07-0
15	1	U3	2K I2C SERIAL EEPROM	MICROCHIP TECHNOLOGY: 24AA02T-I/OT

SCHEMATIC DIAGRAM

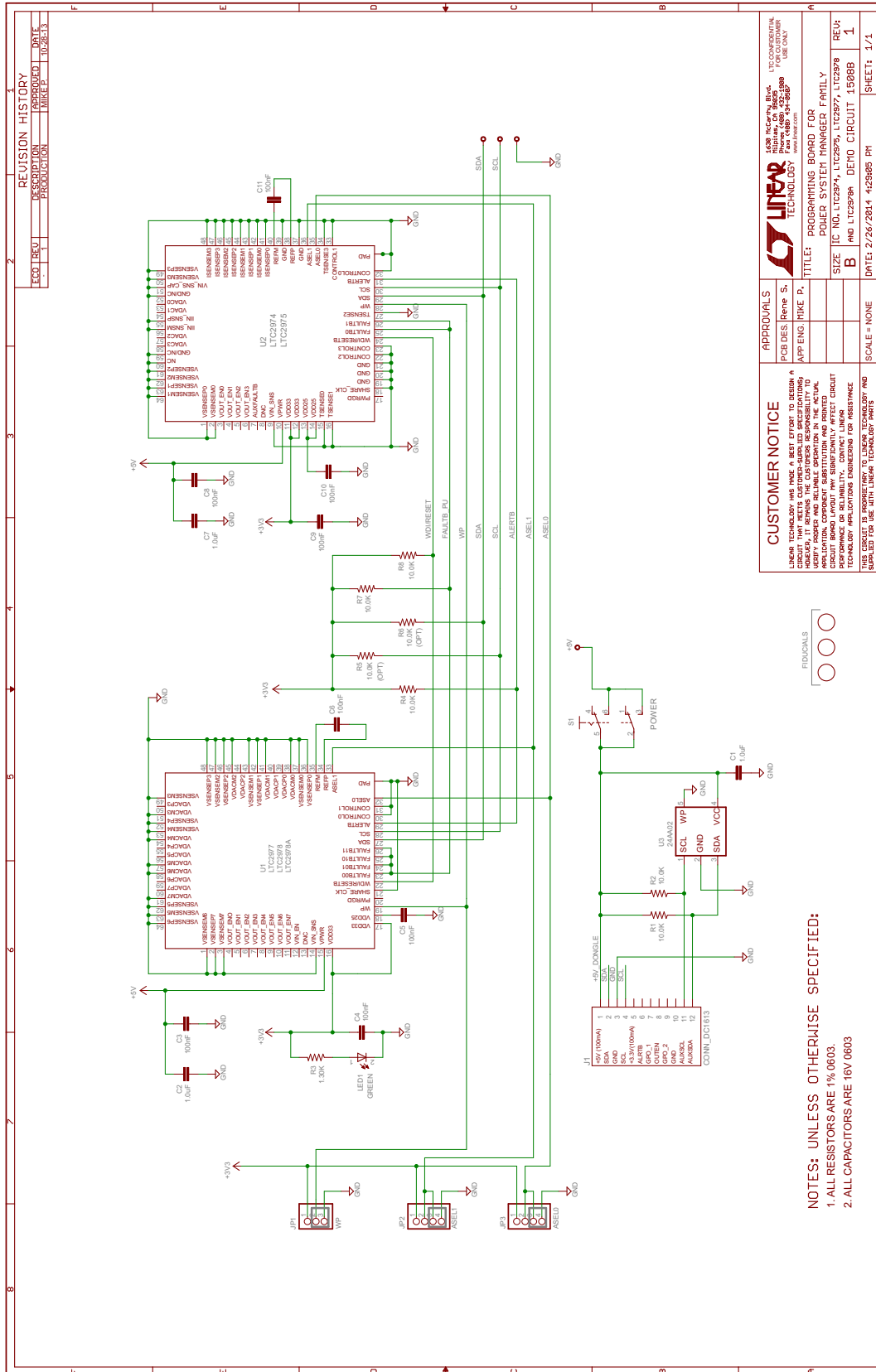

DEMO MANUAL DC1508B

DEMONSTRATION BOARD IMPORTANT NOTICE

Linear Technology Corporation (LTC) provides the enclosed product(s) under the following **AS IS** conditions:

This demonstration board (DEMO BOARD) kit being sold or provided by Linear Technology is intended for use for **ENGINEERING DEVELOPMENT OR EVALUATION PURPOSES ONLY** and is not provided by LTC for commercial use. As such, the DEMO BOARD herein may not be complete in terms of required design-, marketing-, and/or manufacturing-related protective considerations, including but not limited to product safety measures typically found in finished commercial goods. As a prototype, this product does not fall within the scope of the European Union directive on electromagnetic compatibility and therefore may or may not meet the technical requirements of the directive, or other regulations.

If this evaluation kit does not meet the specifications recited in the DEMO BOARD manual the kit may be returned within 30 days from the date of delivery for a full refund. **THE FOREGOING WARRANTY IS THE EXCLUSIVE WARRANTY MADE BY THE SELLER TO BUYER AND IS IN LIEU OF ALL OTHER WARRANTIES, EXPRESSED, IMPLIED, OR STATUTORY, INCLUDING ANY WARRANTY OF MERCHANTABILITY OR FITNESS FOR ANY PARTICULAR PURPOSE. EXCEPT TO THE EXTENT OF THIS INDEMNITY, NEITHER PARTY SHALL BE LIABLE TO THE OTHER FOR ANY INDIRECT, SPECIAL, INCIDENTAL, OR CONSEQUENTIAL DAMAGES.**

The user assumes all responsibility and liability for proper and safe handling of the goods. Further, the user releases LTC from all claims arising from the handling or use of the goods. Due to the open construction of the product, it is the user's responsibility to take any and all appropriate precautions with regard to electrostatic discharge. Also be aware that the products herein may not be regulatory compliant or agency certified (FCC, UL, CE, etc.).

No License is granted under any patent right or other intellectual property whatsoever. **LTC assumes no liability for applications assistance, customer product design, software performance, or infringement of patents or any other intellectual property rights of any kind.**

LTC currently services a variety of customers for products around the world, and therefore this transaction **is not exclusive**.

Please read the DEMO BOARD manual prior to handling the product. Persons handling this product must have electronics training and observe good laboratory practice standards. **Common sense is encouraged.**

This notice contains important safety information about temperatures and voltages. For further safety concerns, please contact a LTC application engineer.

Mailing Address:

Linear Technology
1630 McCarthy Blvd.
Milpitas, CA 95035

Copyright © 2004, Linear Technology Corporation